

Braintech Co.,Ltd.

Braintech Profile 2023



17.07.2023
G.H Jung

1. Company Profile
 - 1.1 Overview & Current Status
 - 1.2 History
 - 1.3 CI, BI Introduction
 - 1.4 Organization Status

2. Products Profile
 - 2.1 EMS PBA ASS'Y
 - 2.2 Production Facility (EMS)
 - 2.3 Household Appliances (1 / 2)
 - 2.4 Personal Smart IVD Analyzer(urinalysis device)
 - 2.5 Smart Functional Pillow

3. About Braintech
 - 3.1 Certificates(Domestic/International)
 - 3.2 Media Introduction
 - 3.3 Exhibition Participation
 - 3.4 Contact Us

- We makes customers happy & healthy!



Quality

Slogan : Do our best. Keep the basic.

We've been recognized as a trustworthy company by many partners for a long time by applying EMS method based on the experience of long-termed manufacturing & product management.



Professional

Having competitive edge of prompt maneuver, stock management, efficient & transparent management by using ERP system



Responsibility

We strive to gain customer's satisfaction & trust, and being future-oriented company based on competitive products, stabled production line & quality management.

Braintech's value is "quality".

1.1 Overview & Current Status

Criteria of 2022

Company Name	Braintech Co., Ltd.	Business License No.	135-81-54946
Date of Establishment	2002. 05. 23.	Main Products	EMS PBA, SMD LINE, Food waste disposer, urine analyzer
CEO	Ji-Hong An	Staff	41
Capital	100,382.26 USD	Webpage	http://www.braintechco.com
Sales	3,337,288.18 USD	E-mail	e-braintech@braintechco.com
Company phone no.	82 31-258-8011	Fax no.	82 31-258-8905
Location (HQ & Factory)	16349) 5F, 16, Pajang-ro 82beon-gil, Jangan-gu, Suwon-si, Gyeonggi-do, South Korea		
R&D/Marketing Headquarters	16270) 3F, 9, Paldal-ro 237beon-gil, Jangan-gu, Suwon-si, Gyeonggi-do, Republic of Korea		

1.2 History

Foundation & Growth (2002~2008)

2002	May	Foundation of Braintech Co., Ltd.
2005	January	Recognition of CLEAN workplace(Minister of Labor No. 12755)
2006	April	Application of liquid type urethane&silicone molding system
2006	April	EMS(Electronic Product Production Service) Operation
2007	June	Quality/Environmental Management System Certification (ISO9001/ ISO14001)
2008	August	Multifunctional Access Control System Development Completed

2nd Leap (2010~ 2019)

2010	April	Management innovation SME certification (MAIN BIZ)
2014	June	Venture Business Certification
2015	May	Company affiliated research
2015	July	Commercialization of food processor completed
2015	August	Selected as promising medium-sized company by Gyeonggi-do
2016	July	Technology Innovation Small Business Certification(INNO BIZ)
2018	April	Medical device manufacturing
2020	April	Certification of GMP
2020	August	SMD LINE Builded

3rd Leap (2020~ now)

2020	October	Medical device manufacturing license
2021	July	Medical Device Item Authorization (BTC-NA39/NA23)
2021	July	Certificate of Sales/Rental Business of Veterinary Medical Devices
2021	November	Import business license for Veterinary Medical Devices
2021	November	Certificate of Veterinary Medical Devices Manufacturing
2021	December	CE IVDR Certification received
2021	December	Certification of designation of innovative products (2021-548)
2022	December	Certification of promising in Gyeonggi-do (2022-089)



- Makes customers happy
- A commitment of confidence to customers
- An eco-friendly company



- A brand of promising customers a happy daily life with perfect quality



- It means that using light to read and test the color changes of test strips

Light Color change Test

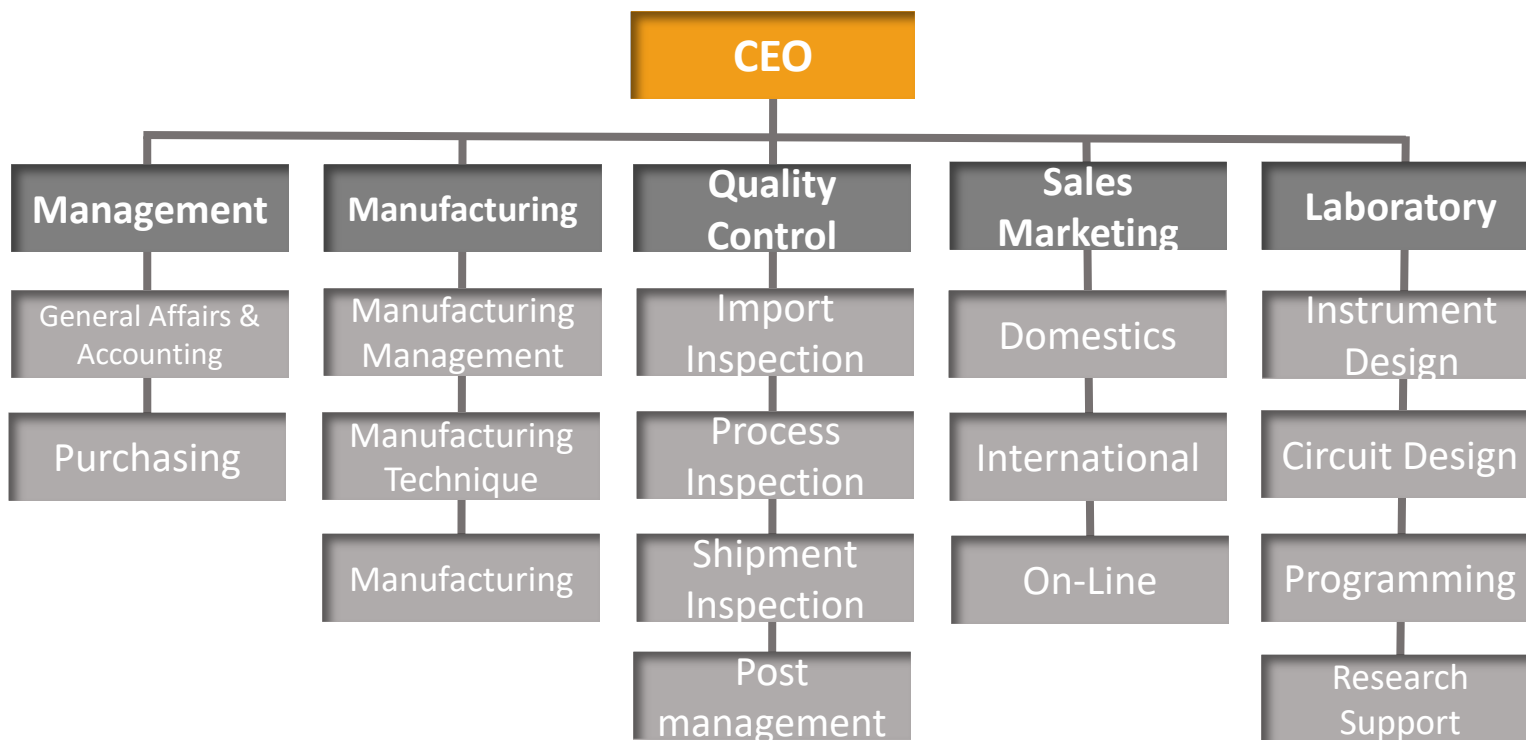

▪ **Staff Status**

Criteria of 2023.02

Section	Board	Managem ent	Manufactu ring	Quality Control	Sales Marketing	Research	Total
Total	2	4	23	2	4	6	41

- Do best to give a pleasant life to customers in an invisible part
Braintech's challenge continues!

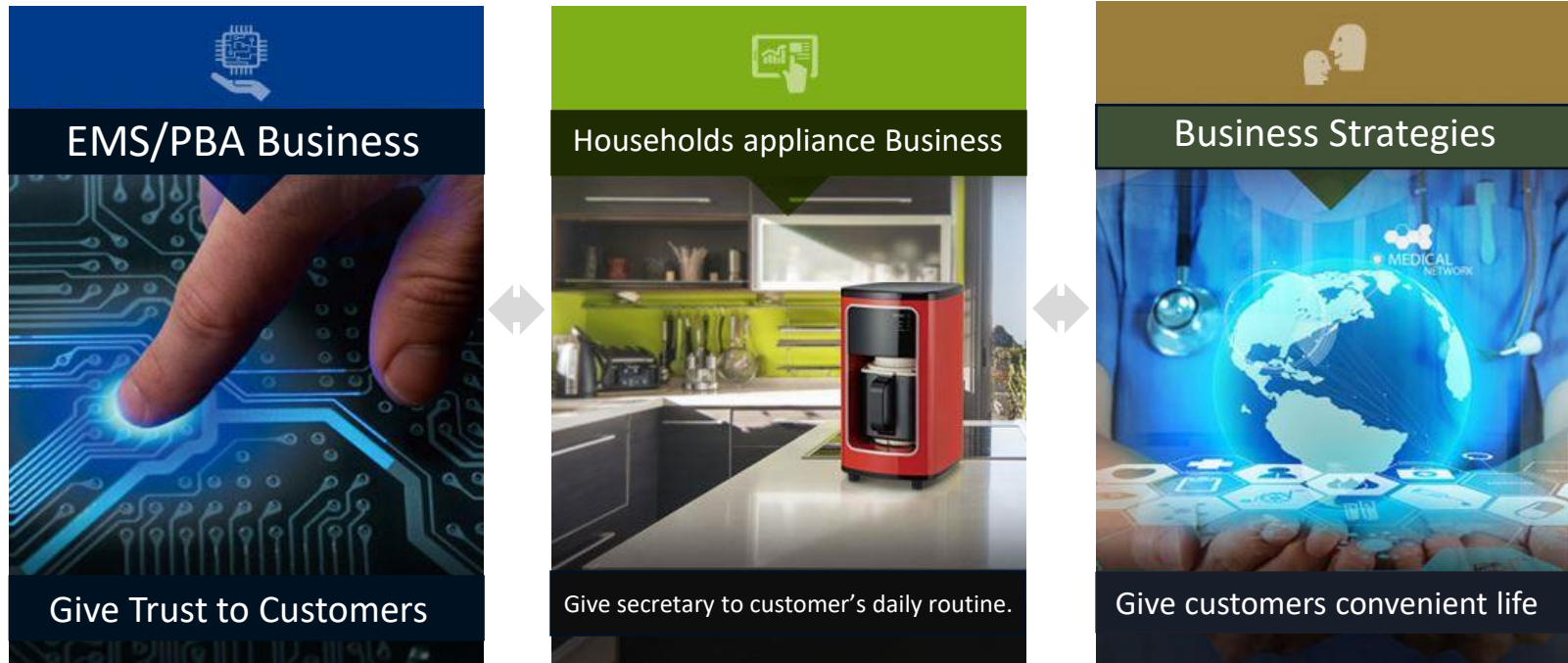

➤ OEM,ODM Design(development)to PBA & SET manufacturing



Control board for Bidet

- Single-phase alternating current
AC 220V / 60Hz /1470W
- Direct supply system
- Safety Function
(Overheating prevention, water level, seizure, water discharge sensor, etc.)



Communication repeater

- Rated input
(Rated & Maximum : less than-47dBm/1FA)
- Rated output (11dBm / Total)
- Gain / AGC Range
(68dB, AGC 50dB:40dB+ for Protection 10dB)



Medical motherboards

- Full automatic control of the pre-sterilization process (Microprocessor embedded)
- Cylinder-type container chamber
- AC 220V / 1.5KW



2.2 Production Facility (EMS)



Touch-up Line



Drying Machine







Wave Soldering M/C

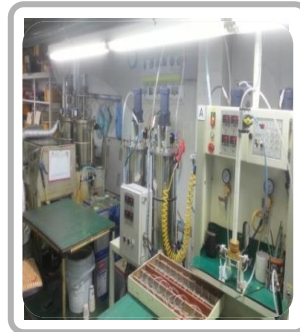

Molding M/C



- 85~90% reduced by one-touch food waste disposing!
- After washing dishes, put all food wastes into cup and push the button once. 85~90% is completely reduced after 3 hours.

-  **Perfect stinks removal**
It is close to a stinkless level since moisture generated during drying is discharged into a sealed container.
-  **Fast processing time**
85~90% of food waste reduced after 3 hours.
-  **Low noise design of less than 35dB**
Making noise quite surround due to less than 35dB low noise disposal.
-  **No need for another maintenance fee**
No need for maintenance costs due to no need for replacing consumables



➤ Under-development of food waste Disposer for commercial use

- Points of Development
 - ✓ Portable hopper type
 - ✓ Automatic water supply
 - ✓ Safety sensor
 - ✓ Non-food substance detection
 - ✓ Automatic sensor
 - ✓ Odor prevention
 - ✓ Emergency safety
 - ✓ Circulating stirring

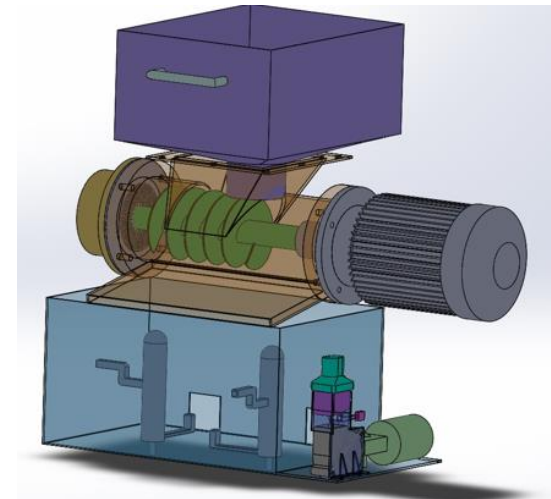

- Do best to give a pleasant life to customers in an invisible part Braintech's challenge continues!

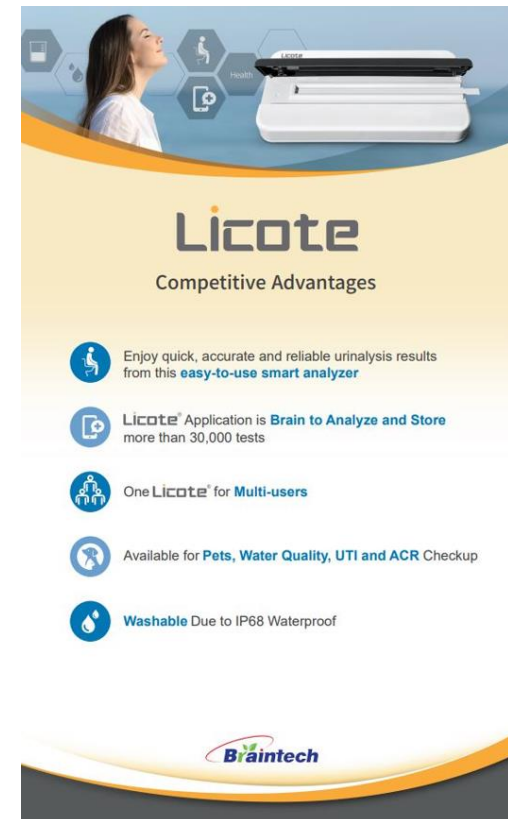

➤ Under-development of Funcional smart air pillow

- We program a procedure of "press controller" which the sensor controls the contraction and expansion of air cushion and analyzes the difference of air pockets height.
- Also, "press compensation algorithm" & Bluetooth scans the contraction and expansion of cushion and connect to smartphone application for adjusting ergonomic heights during night.

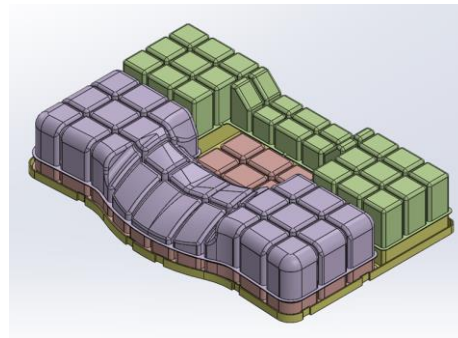

App사용화면 ▶

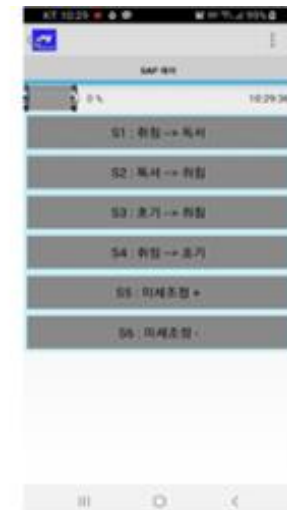
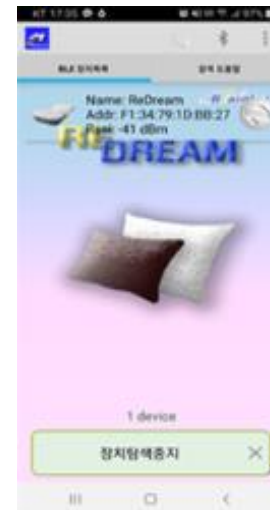

Innovative business & Innovative skill small-medium size business

MAIN-BIZ		INNO-BIZ	
Agency	Ministry of SMEs and Startups	Agency	Ministry of SMEs and Startups
Validity	19.04.13~22.04.12	Validity	19.07.04~22.07.03

제 R100601-01977 호

경영혁신형 중소기업(Main-Biz) 확인서

업 체 명 : (주)브레인테크
 대표 자 명 : 안지홍
 주 소 : 경기 수원시 장안구 파장로82번길 16
 통영빌딩 5층
 유효기간 : 2019.04.13 ~ 2022.04.12

위 업체는 경영혁신형 중소기업 육성사업에 의해 선정된 경영혁신형 중소기업(Main-Biz)임을 확인합니다.

2019년 03월 07일

중소벤처기업부장관

제 R160904 - 00670 호

기술혁신형 중소기업(Inno-Biz) 확인서

업 체 명 : (주)브레인테크
 대 표 자 : 안지홍
 주 소 : 경기 수원시 장안구 파장로82번길 16 (파장화)층
 통 영 5층
 유효기간 : 2019. 7. 4 ~ 2022. 7. 3

위 업체는 기술혁신형 중소기업 육성사업에 의해 선정된 기술혁신형 중소기업(Inno-Biz)임을 확인합니다.

2019년 5월 28일

중소벤처기업부장관

Research Institute & Venture business

Research Institute Certificate		Venture business Certificate	
Agency	Korea Industrial Technology Association	Agency	Korea SMEs and Startups Agency
Certificate on No.	2015113307	Validity	20.06.26~22.06.25

제 2015113307 호

기업부설연구소 인정서

- 연 구 소 명 : (주)브레인테크 부설연구소
[소속기업명: (주)브레인테크]
- 소 재 지 : 경기도 수원시 장안구 갈매로853번길 4
(유리빌딩1층5호실, 유리빌딩)
- 신 고 연월일 : 2018년 04월 23일
(최초인정일 : 2015년 8월 29일)
* 연장일: 임의 연장

과학기술정보통신부

'기초연구진흥 및 기술개발지원에 관한 법률' 제14조의 2제1항 및 같은 법 시행령 제27조제1항에 따라 위와 같이 기업부설연구소로 인정합니다.

2018년 4월 25일

한국산업기술진흥협회장

제 20200401388 호

벤처기업확인서

업 체 명 : (주)브레인테크
 대 표 자 : 안지홍
 소 재 지 : 경기도 수원시 장안구 파장로82번길 16 통영빌딩 5층
 확 인 유 형 : 연구개발기업
 평 가 기 관 : 중소기업진흥공단
 유효기간 : 2020.06월26일 ~ 2022.06월25일

위 업체는 '벤처기업육성에 관한 특별조치법' 제25조의 규정에 의하여 벤처기업임을 확인합니다.

2020년 06월 26일

중소기업진흥공단 이사장

Quality and Environmental Management System Certificates

Quality Management System		Environmental Management System	
Agency	ACE	Agency	ACE
Date of Acquisition	2021.07.20	Date of Acquisition	2021.07.20

--	--	--	--

Overseas Specification Certificates

International Standard Certificate (CE)		FDA Listing	
인증기관	SMB EUROPE SAS	인증기관	C2
취득일	2021.12.03	취득일	2021.10.25

--	--	--	--

Electric Equipment Safety certificates

Electric Equipment Safety		International Standard Certificate (FCC)	
Agency	KTR	Agency	TIMCO ENGINEERING
Date of Acquisition	2018.07.28	Date of Acquisition	2008. 07. 03

전기용품안전인증서
Electrical Appliances Safety Certificate

인증번호(Order No.) : EKCS15-2380

인증번호(No.) : J-K10309-10001

제조사명 : (주)브레인테크 (Manufacturer)

대표자명 : 안자홍 (President)

제조업장소재지 : 경기도 수원시 장안구 파장로24번길 16 동명빌딩 5층 (Factory Address)

제품명 : 음식물처리기 (Product) (Food waste disposer)

기술규격명 : DP-200SH (Model/Model)

용량 : 200 V~, 48 Hz, 100 W (Rating)

제조업체명 : 양현(KMVA) (Supplier/Supplier)

적용기준 : KC8035-1014-01, KC8035-102014-01 (Standard)

2018년 07월 28일
2018 year month day

KTR 한국과학기술시험연구원
Korea Testing Certification Institute

TCB GRANT OF EQUIPMENT AUTHORIZATION Certificate

Issued under the Authority of the Federal Communications Commission

By: Timco Engineering, Inc. 24850 New Road #1 P.O. Box 971 Newbury, FL 32669 Date of Grant: 07/03/08 Application Date: 07/03/08

BRAINTECH CO., LTD
87th FL, DONGYONG BLDG, 161 PALANGDONG JUNGANG-GU, BUNGOK-KU, KYONGGI-DO, KOREA

Attention: ANDREA KIM, VICE PRESIDENT

NOT TRANSFERABLE

EQUIPMENT AUTHORIZATION is hereby granted to the named GRANTEE, and is VALID ONLY for the equipment identified herein. For rules under the Commission's Rules and Regulations, visit: www.fcc.gov

RCG OWNER: BIPNPH/0100
Name of Grantor: BRAINTECH CO., LTD.
Equipment Class: Part 15 Low Power Communication Device

Notes: Frequency: 13.56 MHz, Power: 100mW, Modulation: ASK, Emission: Unrestricted

Grant Notes: FCC Rule Part: 15C, Status: 15C, 13.56 MHz, 100mW, ASK, Unrestricted

Korea Testing Certification Institute

Quality Management System

Medical device manufacturing (ISO13485)		Medical device manufacturing	
Agency	ACE	Agency	KTC
Date of Acquisition	2021.04.16	Date of Acquisition	2020.04.10

ACE

CERTIFICATE NO. AM-21D121.21D

WE HEREBY CERTIFY THAT THE OCCUPATIONAL HEALTH & SAFETY MANAGEMENT SYSTEMS OPERATED BY

브레인테크

FOR THE FOLLOWING ACTIVITIES

Site: 경기도 수원시 장안구 파장로24번길 16 동명빌딩 5층

IS IN COMPLIANCE WITH THE SCHEME REQUIREMENTS

ISO 13485:2016

FOR THE FOLLOWING ACTIVITY

요회학 분석기 및 의료용 PDA 애플리케이션 제조, 개발, 생산 및 판매

Original Date of Certification: 16 Apr 2018 Date of Issue: 16 Apr 2021

Date of Expiry: 15 Apr 2024

Kim Byung Cheol APPROVED BY

ACE

인증번호(No.) : KTC-A88A-7996

의료기기 제조 및 품질관리 기준 적합인증서 (Certificate of GMP)

■ 임계품/제약품(Company name of Applicant / Licensee No.)
(주)브레인테크
BRAIN TECH Co., Ltd.

■ 대표자 (Representative)
안자홍 (An Jiahong)

■ 업체 소재지 (Company address of Applicant)
경기도 수원시 장안구 파장로24번길 16 동명빌딩 5층(파장동)

■ 제조소명 (Name of Manufacturer)
경기도 수원시 장안구 파장로24번길 16 동명빌딩 5층(파장동)

■ 제조소 소재지 (Address of Manufacturer)
경기도 수원시 장안구 파장로24번길 16 동명빌딩 5층(파장동)

■ 제품군 (Category)
의료진단용 기기(In-Vitro Diagnostic Device)

제품/서비스 제조 및 품질관리기준에 적합함을 인증합니다.
(We hereby certify that the above manufacturer complies with Korea Good Manufacturing Practices for Medical Devices for the product group (listed above))

발행일지(Date of Issue) : 2020. 04. 10
유효기간(Date of Expiration) : 2023. 04. 09

KTC 한국기계전기전자시험연구원
Korea Testing Certification Institute

Product Quality Certification

Innovative product certificates		SMEs in Gyeonggi-do Province Certificate	
Agency	The Korean Intellectual Property Office	Agency	Gyeonggi-do
Date of Acquisition	2021.12.24	Date of Acquisition	2011.11.01

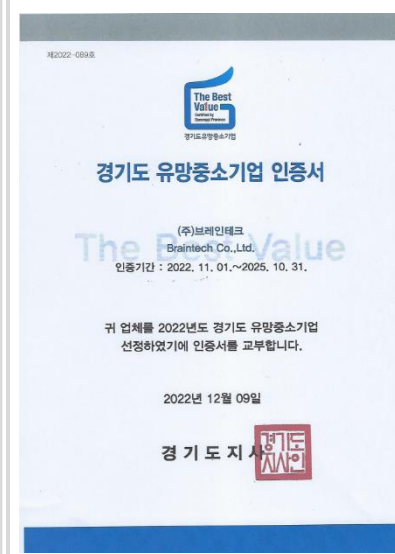
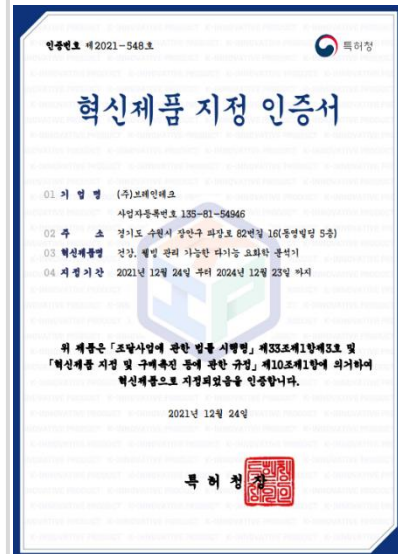

Manufacturing, Import Certificate

Medical device manufacturing		Medical device manufacturing for Veterinary use	
Agency	KFDA	Agency	Agriculture, Forestry and Livestock quarantine Station
Date of Acquisition	2020.09.18	Date of Acquisition	2021.11.22

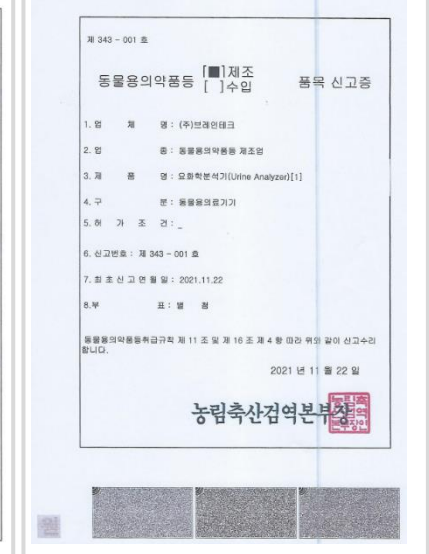
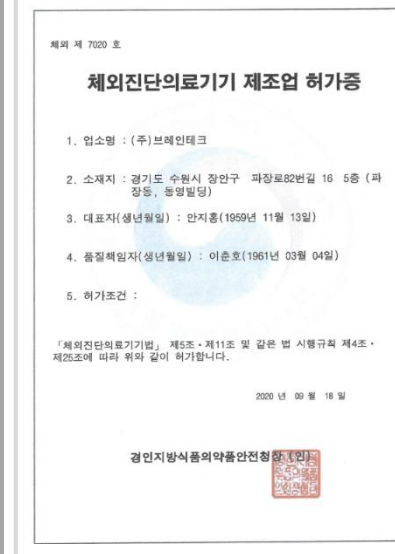

Intellectual Property

Patent		Patent	
Item	Vegetable Drying Grinder	Item	Urine Test Device
Date of Acquisition	2016.02.29	Date of Acquisition	2018.05.11
Registration Date	2017.04.12	Registration Date	2019.09.30



Intellectual Property

Patent		Design Registration Certificate	
Item	Urinalysis Method	Item	Urine analyzer
Date of Acquisition	2018.05.11	Date of Acquisition	2020.06.22
Registration Date	2019.11.07	Registration Date	2021.02.02



Intellectual Property

Trademark Registration Certificate		Trademark Registration Certificate	
Item	BI(BRAINTECH)	Item	BI(COBES)
Date of Acquisition	2018.01.29	Date of Acquisition	2018.01.29
Registration Date	2018.08.31	Registration Date	2018.11.07



Intellectual Property

Trademark Registration Certificate		Trademark Registration Certificate	
Item	BI(Licote)	Item	EU trademark rights
Date of Acquisition	2018.12.02	Date of Acquisition	2021.09.07
Registration Date	2020.10.29	Registration Date	2021.12.16



3.2 Media Introduction



[Gyeonggi-do]



[Suwon-si]



3.3 Exhibition Participation (2015~2016)

■ Germany IFA Exposition 2015~2016



■ China Canton Fair 2015~2016



■ Hongkong Exposition 2016



3.3 Exhibition Participation (2018~2019)

■ G-FAIR HoChiMinh City Vietnam 2018



■ Medical Bio Pioneering India New Delhi & Hyderabad 2018



■ Medical Bio Pioneering Saudi Arabia Riyadh 2018



■ 2019 Korean wave trade meeting Myanmar & Singapore



3.3 Exhibition Participation (2021~2022)

2021 KiMES & Export Consultation in Busan



2021 GITEX In UAE



2021 Thailand Amarin Baby & Kids



2022 CES USA in Las Vegas



2022 Korea-East Africa Export Consultation In Kenya



2022 MEDICA In Germany Dusseldorf



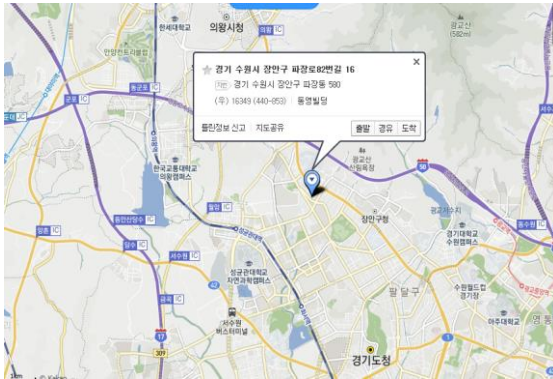

- HQ & Factory**
 16349) 5F, Pajang-ro 82beon-gil, Jangan-gu, Suwon-si, Gyeonggi-do
 Tel.) +82 31-258-8903 Fax) +82 31-258-8905

For cars : North Suwon IC, East Suwon IC

Public transportation(Bus)

: GangNam3000, Sadang7770,

Jamsil.Pangyo1007(One-time transfer at Jangan Gate)

To Suwon station : 777, 900, 310, 301, 5, 30, 30-1

To Osan : 300, 300-1

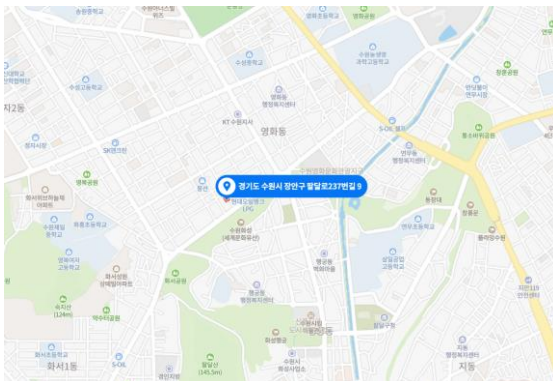

- R&D/Marketing Headquarters**
 16270) 3F, 9, Paldal-ro 237beon-gil, Jangan-gu, Suwon-si,
 Gyeonggi-do, Republic of Korea
 Tel.) +82 31-258-8011 Fax) +82 303-0959-8022

For cars : North Suwon IC, East Suwon IC

Public transportation(Bus)

: GangNam3000, Sadang7770,

Jamsil.Pangyo1007(One-time transfer at Jangan Gate)

To Suwon station : 777, 900, 310, 301, 5

To Osan : 300, 300-1

Thank you

- ❖ *Keep your health when you're healthy!*
- ❖ Personal smart self-healthcare device **LICOTE!**
 - ❖ Monitor your health by **urine test**